

0 600 874 003

Stand } 02-02

Issue } 06-01-27

Fig./Abb. 3

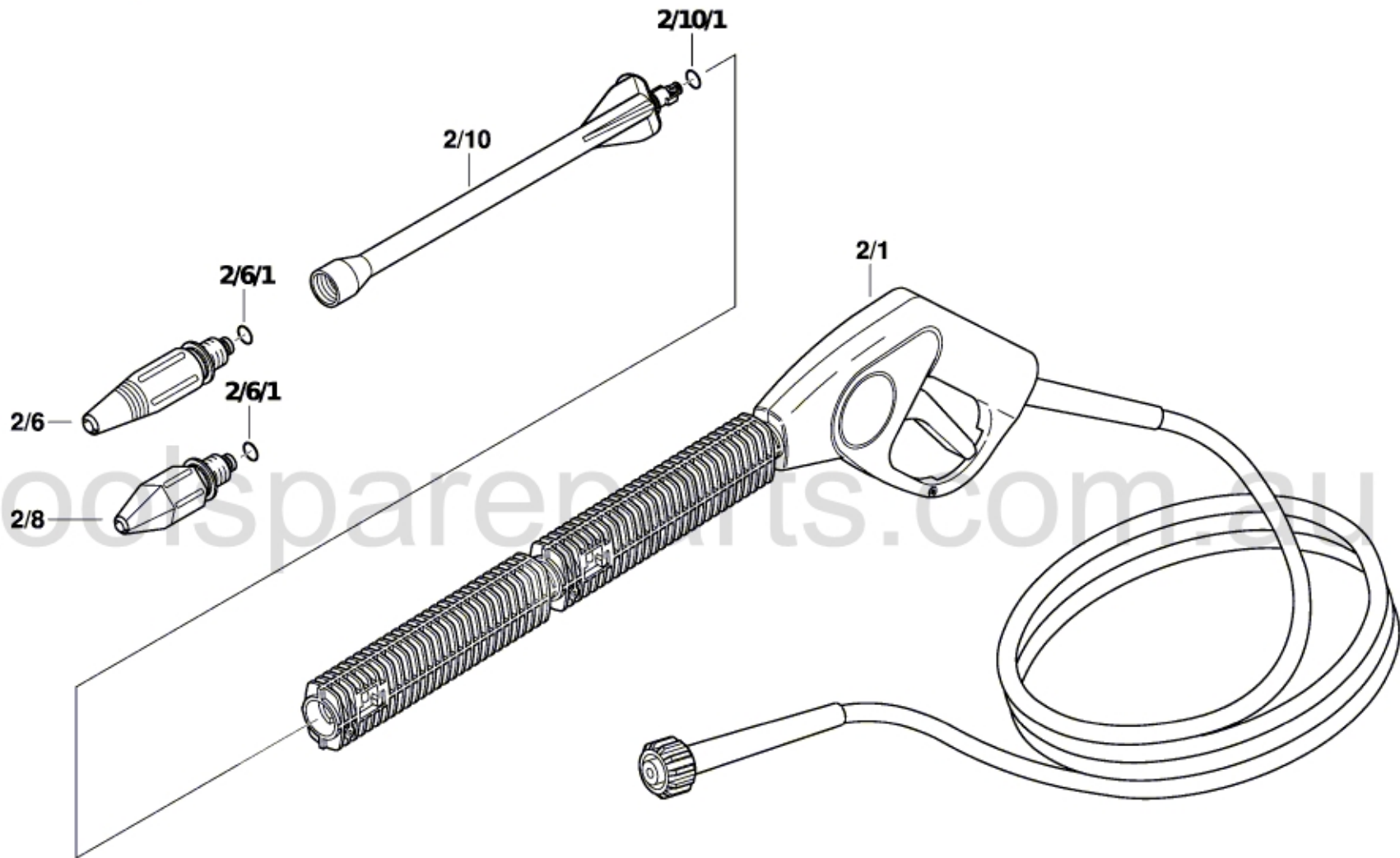

Änderungen vorbehalten
Modifications reserved
Modifications reserves
Salvo modificaciones